



SOFFIT & FASCIA Install Quick Tips

VENTILATION

THE NEED FOR VENTILATION

WHAT IS VENTILATION?

Ventilation ensures a continuous supply of air through the attic space.

It consists of 50% intake under the eaves and 50% exhaust near or at the peak of the roof.

The exhaust must be at least 3' higher than the intake system.

WHY VENTILATION IS ESSENTIAL TO PREVENT HEAT BUILD-UP

In summer, ventilation reduces attic temperatures by as much as 30°F – extending shingle life and reducing energy bills.

Heat in an unventilated attic can cause temperatures to exceed 150°F, causing damage to the shingles and roof sheathing and possibly radiating to the living area.

Ventilation rids the attic of excess moisture:

- dampness contributes to mold and mildew growth which can lead to major health problems
- condensation can damage wood, plaster, paint and insulation

In winter, ventilation helps to keep the roof uniformly cold to prevent ice damming.

By ventilating, you are preventing moisture problems and extending the life of shingles, insulation and other building components.

NFA

You will find that most codes will specify a net-free area (NFA) of:

- 1 sq. ft. for each 150 sq. ft. of ceiling area (if the ceiling has no vapor retarder).
- 1 sq. ft. for each 300 sq. ft. of ceiling area (if the ceiling has a vapor retarder).

The ventilation area should be divided 50/50 between high and low vents (preferably soffit and ridge vents).

Since these specifications were written before today's concerns for energy conservation and resulting trends towards tighter house construction, they may not be sufficient for every structure. Always check the manufacturer's recommendations for proper use of ventilating systems and vapor retarders.

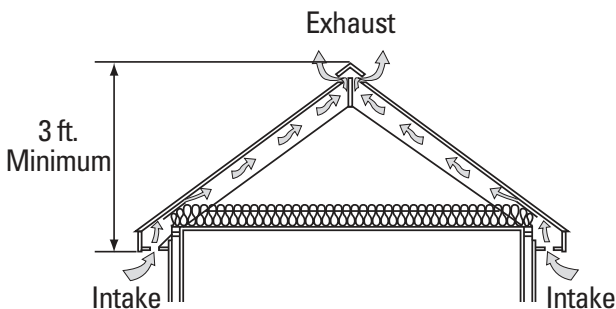

"Proper ventilation" consists of 50% intake under the eaves, and 50% exhaust near or at the roof peak, at least 3 feet higher than the intake system.

Ventilation: the Vital Factor in Roof Performance

HEAT – A NATURAL ENEMY OF ASPHALT

Heat, along with ultraviolet light, causes asphalt shingles to age through chemical changes that stiffen the asphalt. Initially, shingles are protected from ultraviolet light by the granules embedded in their surface. As long as the asphalt stays flexible the granules will stay in place. Eventually, however, the shingles become brittle and the granules break loose and gradually wash away.

Excess heat accelerates this aging process, causing the shingles to become prematurely brittle and show all the signs of aging, such as cracking and curling. The aging shingles lose their granules at a faster and faster rate and subject them to even more rapid deterioration from ultraviolet light.

Fortunately, accelerated shingle aging can be slowed by reducing

the heat from directly below the roof deck. Proper attic ventilation is the best way to achieve this objective and is therefore a key component of the shingle roof system.

WHAT VENTILATION DOES

Ventilation is a system of intake and exhaust that creates a flow of air. Effective attic ventilation provides year-round benefits, creating cooler attics in the summer and drier attics in the winter, protecting against damage to materials and structure, helping to reduce energy consumption and helping to prevent ice dams.

With poor ventilation, summer sunshine can cause a terrific build-up of heat in the attic space. In a home with poor ventilation, the heat in the attic may eventually reach 140°F on a 90°F day. If the unventilated attic is heavily insulated, that heat will stay there much of the night, perhaps slowly migrating to the home's interior. An overheated attic, combined with moisture, can also be damaging to roof decking and roofing shingles, causing them to distort and deteriorate prematurely.

In the winter, again in a house with poor ventilation, moist, warm air from the lower portions of the home will tend to rise through the ceiling area into the attic, especially through bypasses where electrical and plumbing fixtures are installed. In a cold attic, the warm, moist air condenses on the cold surfaces of the rafters, the nails and other metal, and the attic side of the deck. This water can create several problems.

First, the condensation can swell the deck, causing waviness and buckling of both the deck and the shingles. Second, the water can rot the roof deck, destroying its ability to carry loads (like a roofing crew) and its nail-holding capability. Third, severe condensation can drip onto the insulation, reducing its effectiveness and possibly seeping through to the ceiling below.

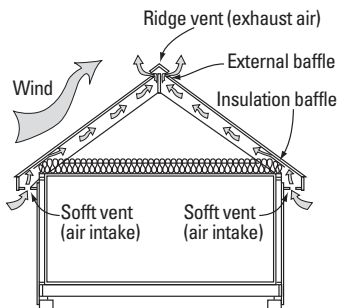

ICE DAMS

Another winter problem caused by poor ventilation is the formation of ice dams. Ice dams form in cooler climates in the winter when heat collects in a poorly ventilated and/or inadequately insulated attic. Built-up attic heat combines with the sun's warmth to melt snow on the roof, even though outside temperatures may be below freezing. Then the flow of melting snow refreezes at the eaves and gutters. This freeze-thaw cycle can result in a pool of water that can back up under roof shingles and behind fascia boards, soaking roof decking and wall sheathing, damaging exterior and interior walls, peeling paint and ruining ceilings. Soaked lumber and building materials lead to secondary problems: wood rot, bug infestation, mold and degradation of structural integrity.

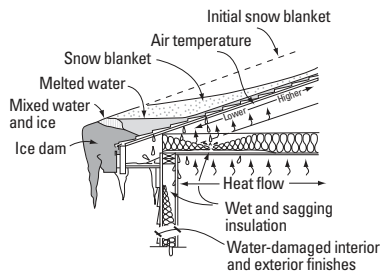

EXHAUST VENTS

Exhaust vents are designed to permit an efficient, unobstructed outflow of attic air. These units must be designed to prevent (or at least minimize) rain and snow infiltration. Exhaust vents must be used with intake vents to provide proper high/low balance and thus an adequate flow of air through an attic.

Exhaust vents are available in different designs:

Roof louvers

Roof louvers (also called roof pots) are installed as close to the roof ridge as possible to allow maximum release of moisture and overheated air. Because they're installed near the ridge, they provide a continuous airflow along most of the underside of the roof sheathing. The airflow pattern isn't uniform, however, so for maximum effectiveness, vents should be spaced equally along the roof.

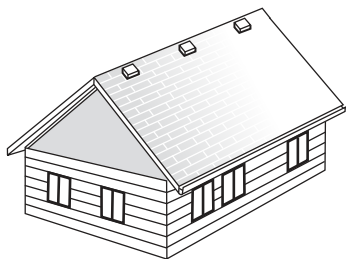

A roof vent is an exhaust vent located near the ridge.

Gable louvers

Gable louvers are typically installed in the gable ends of the house.

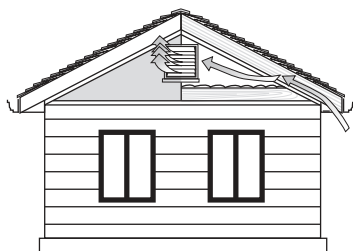

The gable-louver vent, an exhaust vent, allows unwanted air to flow out of the attic.

Note: Sometimes louvers are installed in opposite gable ends, without intake venting, in the mistaken assumption that a good "cross flow" of air can provide adequate ventilation.

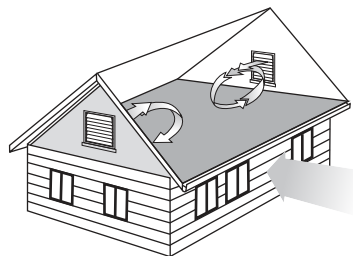

With wind blowing perpendicular to the ridge, the louvers act as both intake and exhaust vents.



With wind blowing parallel to the ridge, airflow dips toward the attic floor leaving the hottest air still on the underside of the roof sheathing.

Ridge vents

Ridge vents offer unique advantages compared to other types of exhaust vents.

Maximum efficiency ridge vents are designed to draw heated air from an attic regardless of wind direction or force.

In addition, when little wind force exists, ridge vents take full advantage of the thermal effect to maintain air circulation across the underside of the roof sheathing. Warm air rises to the ridge and exhausts through the vent.

That allows a continuous flow of cooler air to enter at intake vents. Only ridge vents use thermal effect efficiently and effectively, because only ridge vents provide continuous and uniform air movement along the full length of a roof.

Note: For best results, intake venting should be divided equally along both sides of a structure.

Ridge vent shorter than the ridge length presents an unattractive “broken” appearance.

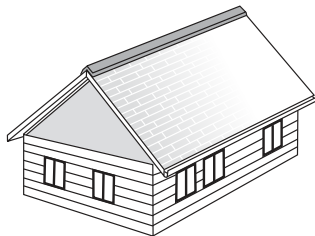
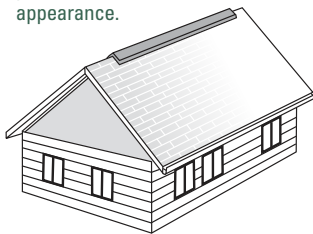

Uniform air movement:

Because ridge vents run the entire length of a roof, they provide a uniform flow of air along the underside of the roof sheathing. That air movement helps eliminate “hot spots” that can develop with other types of exhaust vents – even powered vents. No other exhaust vents provide this type of airflow pattern.

Maximum visual appeal:

Most ridge vents offer a low-profile design that minimizes its appearance on a roof. Shingle-over designs allow optimum blending with other roof materials.

Wind turbines

Wind turbines use a moving part to help exhaust from an attic. That moving part consists of a series of specially shaped vanes that turn wind force into a rotary motion. As the spinning vanes gain velocity, they create an area of negative air pressure. That negative pressure, in turn, pulls air from an attic.

Although not as effective as ridge vents, wind turbines provide a low-cost alternative in areas where consistent wind speeds of at least 5 mph are typical. Without that minimal wind speed, wind turbines act essentially as roof louvers.

When the wind is blowing, however, wind turbines can be effective air movers.

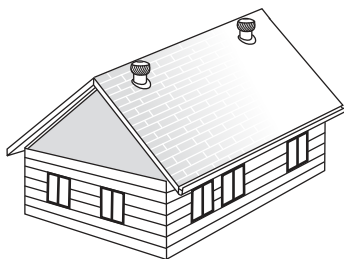

Wind turbines are located near the ridge and are used to exhaust air from the attic.

Power attic ventilators

Like a wind turbine, a power fan uses the rotary motion of blades to draw hot air from the attic. But instead of using wind power to drive the blades, power fans use electricity to drive high-efficiency motors.

Unlike a wind turbine, however, the effectiveness of a power fan isn't dependent on wind force. Instead, a power fan is turned on and off as needed, automatically, with thermostat and humidistat controls.

Although a power fan can move a large volume of air, typically a single unit cannot “vacuum” all

hot air from an attic. Usually, to provide uniform air movement along the underside of roof sheathing, a series of power fans must be spaced equally along a roof.

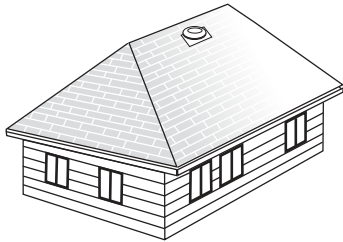

Power fans are used to move large volumes of air – a good option for hard-to-vent hip roofs.

NEVER MIX TWO TYPES OF EXHAUST VENTS

When ridge and soffit ventilation is added to an attic with other vents in place, such as gable end vents, box or turbine static vents, or power fans, you must remove or block off the other ventilators. When installed properly, ridge and soffit systems draw air in the bottom (soffits) and out the top (ridge). Other open ventilator holes in the roof or gable will shortcut the low-to-high draft and diminish the ventilation effectiveness.

CAUTION:

Ridge Vents & Power Vents Do Not Mix

Power vents can actually pull air into an attic through a ridge vent, making it act as an intake. This reversed airflow could bring moisture into the attic and make the ridge vent ineffective.

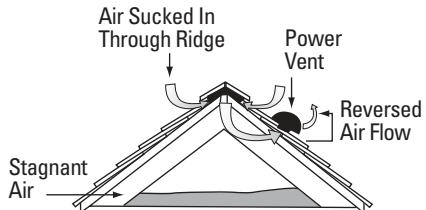

SOFFIT VENTILATION

WHY YOU SHOULD INSTALL FULLY VENTED SOFFIT

- The more ventilation area you provide, the more effective the home will be at venting moist air.
- Soffits should be fully vented for maximum airflow.
- The intake of fresh air through the home allows moisture and excess heat to escape.
- Condensation occurs when air contacts a cold surface.
- By preventing trapped moisture, vented soffits help prevent moisture problems like rotting, mold and ice build-up.
- Maximum air circulation also improves indoor air quality to prevent problems like Sick Home Syndrome.

HOW TO INSTALL QUALITY EDGE TRUVENT SOFFIT

HOW TO BEGIN

Soffit is the name given materials used to enclose the underside of eaves and porch ceilings. The installation of soffit will determine the positioning of the inside and outside corner posts. It also is necessary to complete the soffit, or install the soffit moldings, before the final course of siding is installed on the wall.

Note: Proper attic ventilation is important for any home. Consult a local building official for the appropriate requirements for a specific geographical area, and use vented soffit or other vented products as necessary.

PREPARATION

1. Inspect and plan the job in advance. For residing application, nail down any loose panels, boards, or shingles. Check surfaces for straightness and fur when necessary. Surfaces should be uniform and straight from various viewing angles.
2. The procedure used to install soffit depends on the construction of the eaves. There are two different types of eaves:
 - **Open eaves** with exposed rafters or trusses are typical of new construction. Open eave installation procedures are also used when removing damaged soffit during a residing project.
 - **Enclosed eaves** (eaves with a wood or plywood soffit already in place) are typical of residing projects.

Note: In most new construction application the existing soffit area will be an open area with exposed rafters. In most remodeling situations a solid wood soffit will be present.

INSTALLATION OVER OPEN EAVES

There are several ways to install receiving channels for soffit. You can use accessories such as J-Channel or Frieze-Channel. The best approach is to select a method that works most effectively with the construction techniques used to create the eave.

1. Examine the eaves illustrations and find one that most closely resembles the construction methods used on your particular projects (Figures 1 through 4).

2. Install the receiving channels following the details shown in the illustrations. Nail channels every 5' positioning the nail in "pre" drilled holes – see detailed instructions.
3. Fasten channels, just snug to take out excessive play. Do not overdrive fasteners.

Note: Recommended nailing for soffit panels is 16" on center, however, if the eave span is over 18", nailing strips must be installed (Figure 4). In areas with high wind restrictions, nailing should not exceed 12" on center.

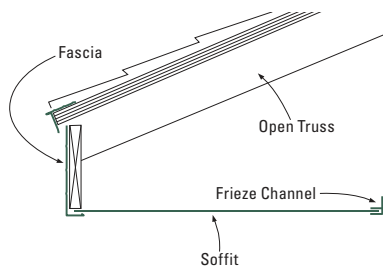

Figure 1

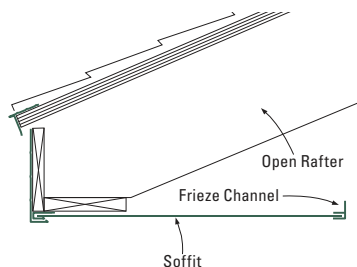

Figure 3

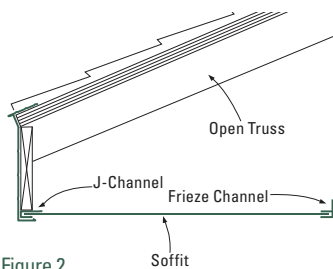

Figure 2

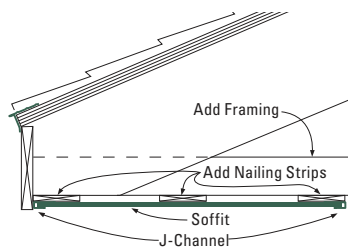

Figure 4

INSTALLATION OVER ENCLOSED EAVES

The procedure used to install soffit over enclosed eaves is almost identical to that used for open eaves. The major difference is the installation of the J-Channel at the wall line rather than F-Channel (Figures 5 and 6).

Determine the preferred method of installing soffit at the fascia board.

Note: If the existing soffit is rotted or damaged, remove it completely before installing soffit, then use the instructions for open eaves.

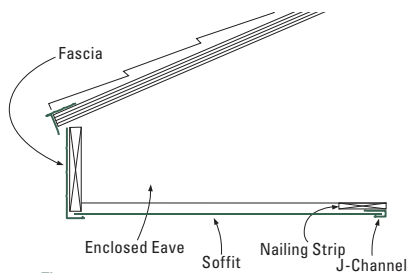

Figure 5

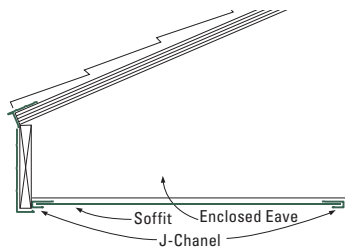

Figure 6

SOFFIT INSTALLATION

1. Along the wall, strike a chalk line (Figure 7) that is parallel and level with the bottom of the existing wood sub-fascia board.
2. A receiving channel must be installed along the chalk line making sure to allow for the depth of the soffit panels. In all of the options listed, receiving channels should be attached every 16". In most situations you will not be required to install a receiving channel on the fascia board.

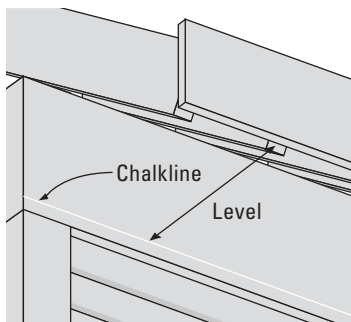
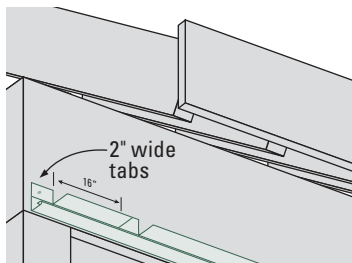
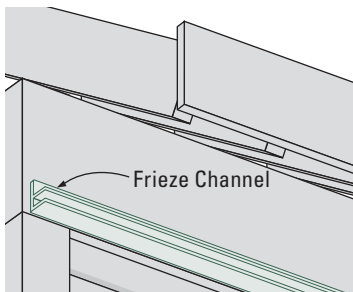

Figure 7

For New Construction

- A Frieze-Channel can be used to receive the soffit panels.



For Remodeling

- A J-Channel can be attached directly to the existing wood soffit.

- A wood block can be used as a nailing surface for a J-Channel.

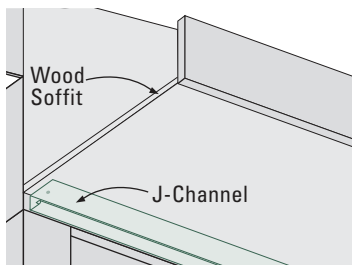
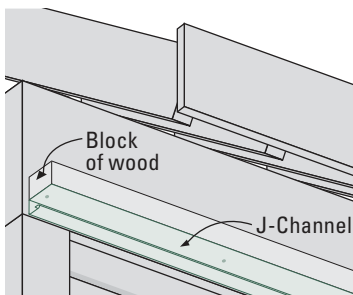

- A J-Channel can also be modified by cutting 2" wide tabs in the nailing flange. Bend these flanges back and nail to the wall.

For Both

- Cut the soffit panels to the required length minus $\frac{1}{4}$ " to allow for movement.

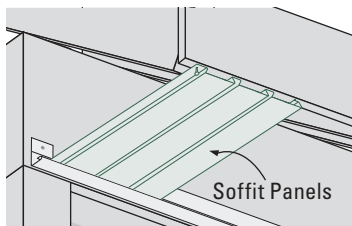

- Insert panel into the wall channel making sure it is fully engaged into the lock of the preceding panel.
- While nailing the panel into the bottom of the fascia board, make sure panel is square.

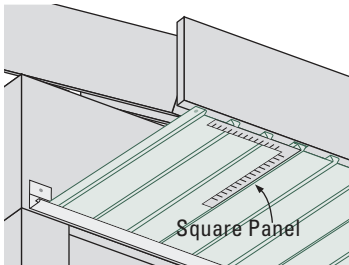

TRANSITIONS

- When a soffit changes direction, such as at inside and outside corners, install a transition channel by using pre-formed Miter Divider, or two pieces $\frac{1}{2}$ " J-Channel placed back to back.
- Miter soffit panels to fit.

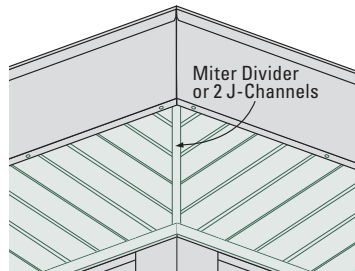

WIDE SOFFIT INSTALLATION

- An intermediate nailing support should be used when installing panels over 24".
- Nail panels at the center of the panel and at the nail flange.

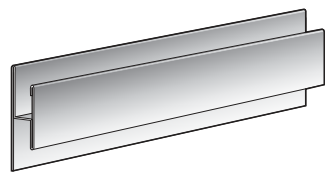
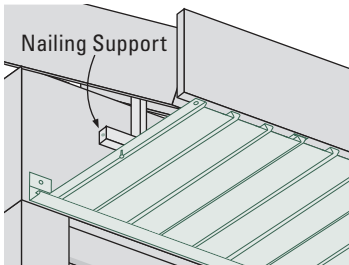

Miter Divider



J-Channel

INSTALLING PRE-ENGINEERED FASCIA

- It's recommended to pre-drill a hole $\frac{1}{16}$ " larger than the nail diameter in the bottom edge "before" nailing every 5'.

DO NOT FACE NAIL

- Insert fascia under drip edge.

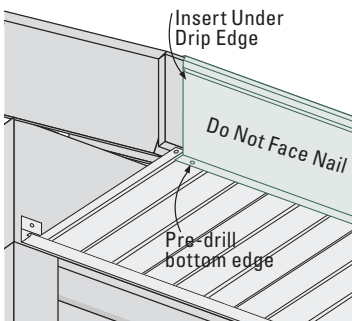

PORCH CEILINGS

New construction

- J-Channels should be installed around perimeter of porch area.
- Intermediate nailing supports need to be used at 24" on center.
- Nail panels 24" on center at the nail flange and in the V-Grooves.

Remodeling

- J-Channels should be installed around perimeter of porch area.
- Panels can be installed directly onto existing wood ceiling substrate.
- Nail panels 24" on center.

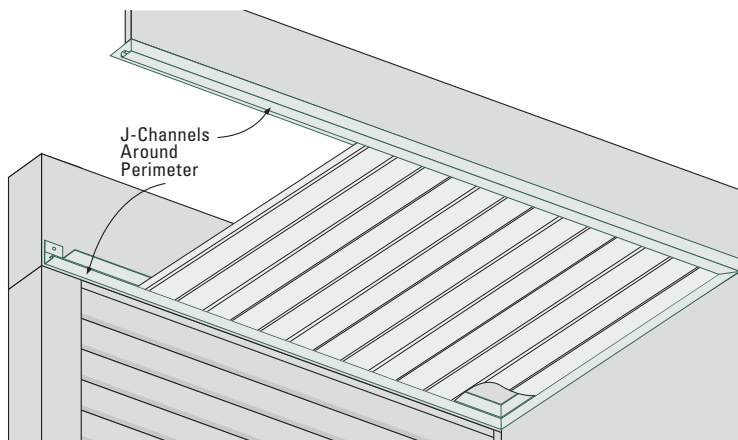

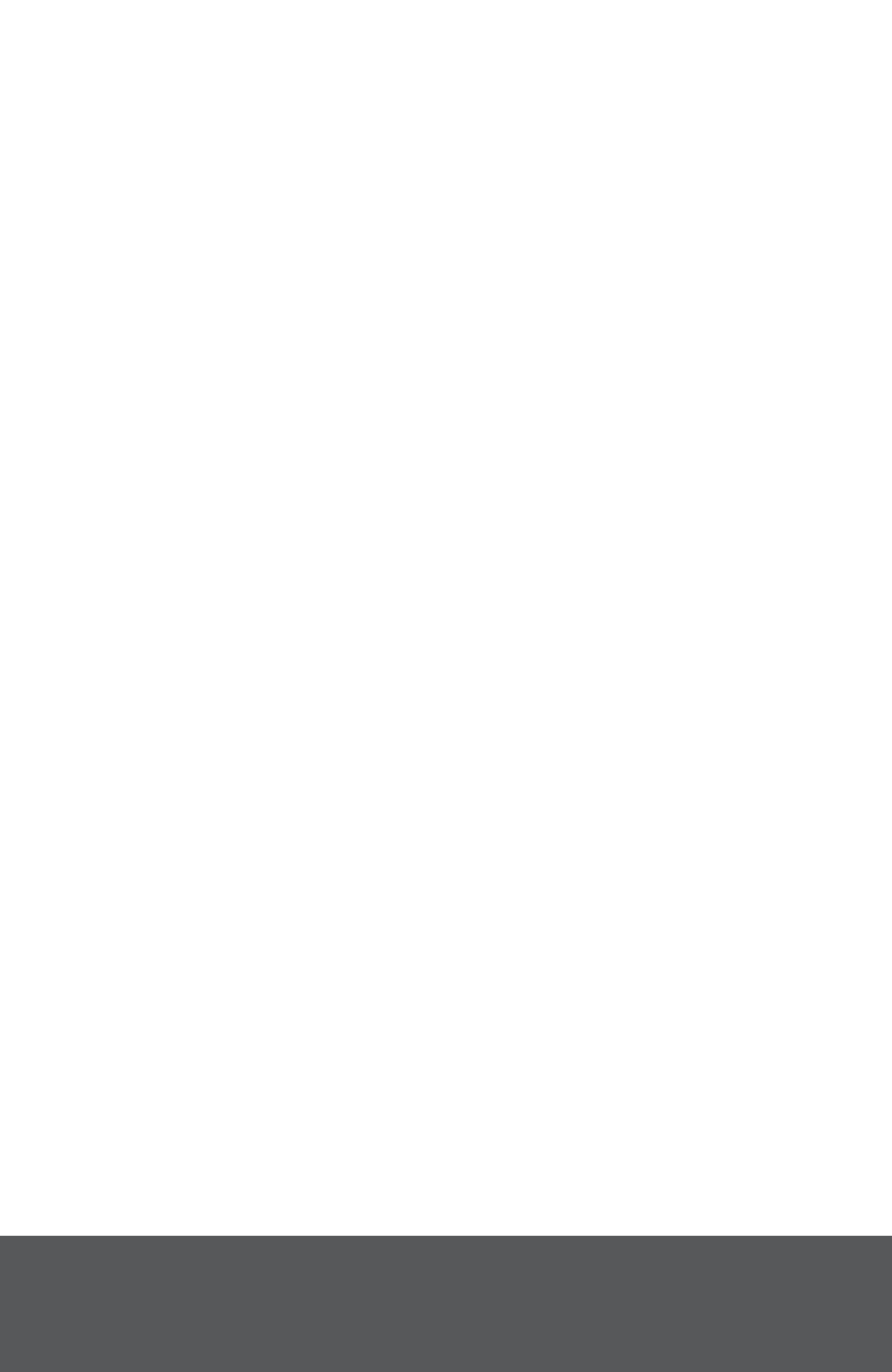



2712 Walkent Drive, Walker, Michigan 49544
Phone: 888-784-0878 Fax: 616-735-3844
www.qualityedge.com